



# Technical data

Date	6/22/2022
Offer N.	---
Pump Type	CA50-315AN

Client	NTD Pumps Co.,LTD	Reference	---
--------	-------------------	-----------	-----

## Pump data

Pump body and rear shield	Cast iron GJL-250	Bare-shaft centrifugal pumps manufactured in accordance with EN 733 and widely used in water supply, pressure boosting and fire fighting systems. The pumps are equipped with counter flanges and can be provided with the motor assembled on a common base frame. In the standard version the pumps have cast iron impeller and mechanical seal. On request are available bronze or stainless steel AISI316 impeller and gland packing seal. In the "X" version all the wet parts of the pump are made of AISI 316.
Impeller	Cast iron GJL-250 On request bronze or stainless steel AISI 316	
Pump bearings support	Cast iron GJL-250	
Type of seal	Mechanical ceramic-graphite On request: gland packing graphite	
Pump shaft end	Stainless steel AISI 316 EN X5CrNiMo17-12-2	
Liquid temperature	-10°C +90°C	
Operating pressure	Max 10 bar	

P2	Motor Size	Q (m3/h - l/min)								
		0	42	54	66	78	96	120	132	144
(kW)	280S	0	700	900	1100	1300	1600	2000	2200	2400
		H (m)								
75	280S	146.1	146.9	147.4	146.9	145.3	141.2	134.1	130	125.8

## Technical Sheet

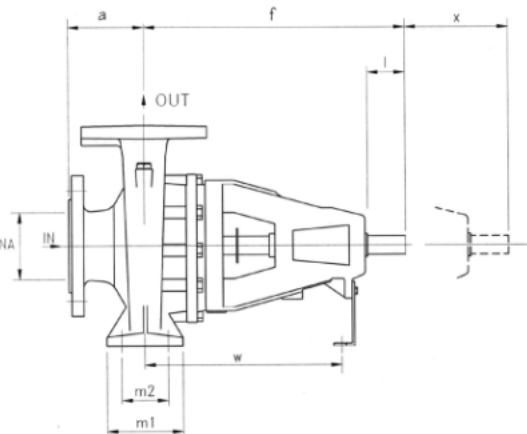
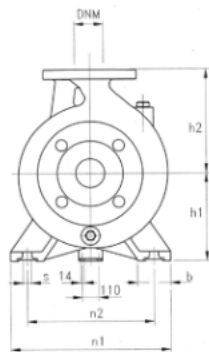
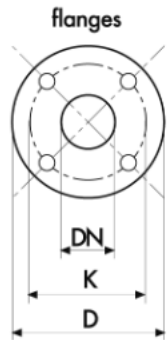

DN	D	K	holes	
			n°	Ø
32	140	100	4	18
40	150	110	4	18
50	165	125	4	18
65	185	145	4	18
80	200	160	8	18
100	220	180	8	18
125	250	210	8	18

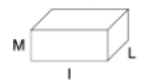

DNA	DNM	DIMENSIONS (mm)																			Kg
		a	f	h1	h2	m1	m2	n1	n2	s	b	i	d	t	u	x	w	l	L	M	
80	50	125	470	225	280	125	95	345	280	14	65	80	32	35,3	10	100	340	655	465	620	94,5

## Notes

The information may be subject to change without notice. It is always advisable to contact our commercial department in order to get further information about the products, their technical specifications and warranty conditions. The Company is expressly relieved of any liability for the purchasing of a product not in line with the customer's needs, if not consulted beforehand for a specific consultancy.



### Working Curves

Pump type: CA50-315AN

Curv n°:	CA50-315AN
Date:	6/22/2022
Pump Speed	2900 rpm

Q (m3/h) 100 | H (m) 140 | Power [kW] 55.49 | Efficiency % 68.56 | NPSH (m) 5.09

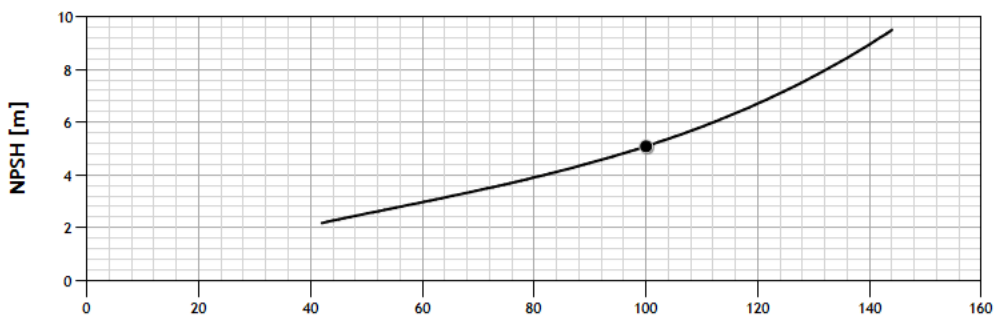
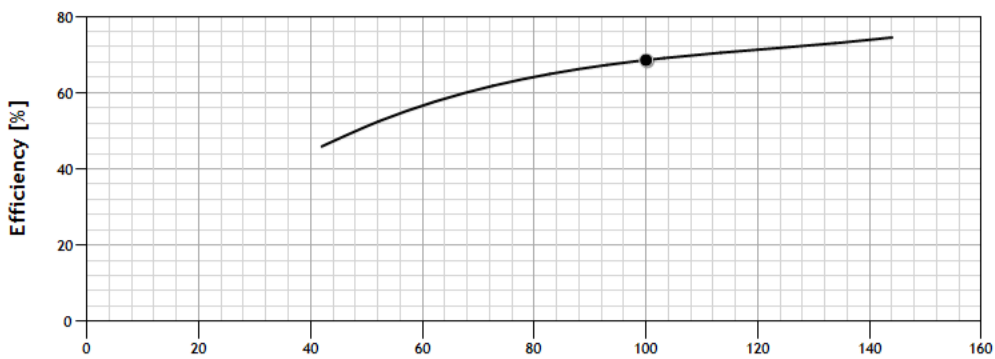
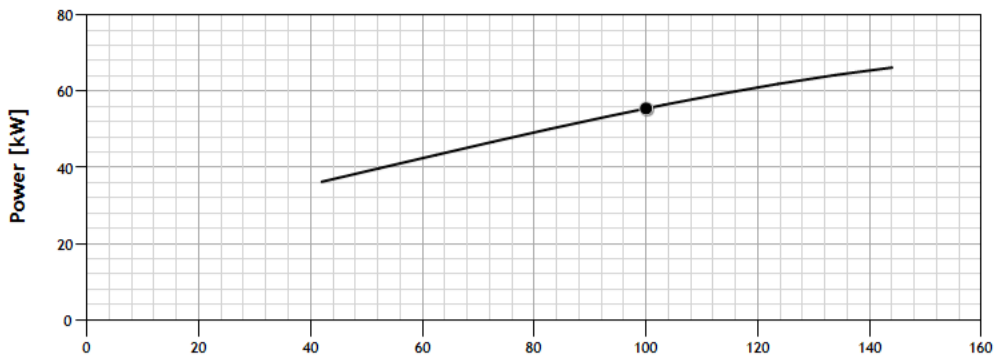
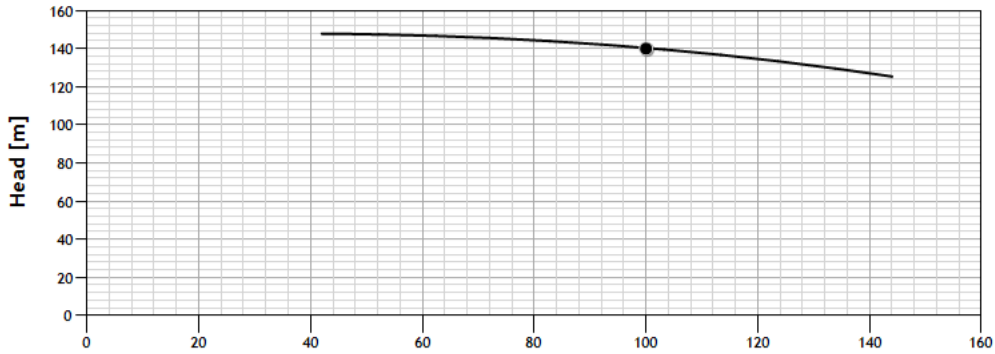

Flow Rate [m3/h]

MEI ≥ 0.4 (regulation EU N. 547/2012)  
Tolerances according to UNI ISO 9906 grade 3B