



# Technical data

Date	6/22/2022
Offer N.	---
Pump Type	CA32-160A

Client	NTD Pumps Co.,LTD	Reference	---
--------	-------------------	-----------	-----

Pump data	
Pump body and rear shield	Cast iron GJL-250
Impeller	Cast iron GJL-250 On request bronze or stainless steel AISI 316
Pump bearings support	Cast iron GJL-250
Type of seal	Mechanical ceramic-graphite On request: gland packing graphite
Pump shaft end	Stainless steel AISI 316 EN X5CrNiMo17-12-2
Liquid temperature	-10°C +90°C
Operating pressure	Max 10 bar

Bare-shaft centrifugal pumps manufactured in accordance with EN 733 and widely used in water supply, pressure boosting and fire fighting systems. The pumps are equipped with counter flanges and can be provided with the motor assembled on a common base frame. In the standard version the pumps have cast iron impeller and mechanical seal. On request are available bronze or stainless steel AISI316 impeller and gland packing seal. In the "X" version all the wet parts of the pump are made of AISI 316.

P2	Motor Size	Q (m3/h - l/min)									
		0	6	7.5	9	12	15	18	21	24	27
(kW)		0	100	125	150	200	250	300	350	400	450
		H (m)									
4	112M	36.1	36.2	36	35.6	34.6	33.2	31.4	28.9	25.7	22.1

## Technical Sheet

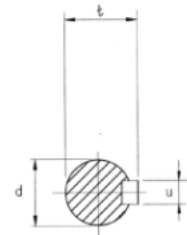
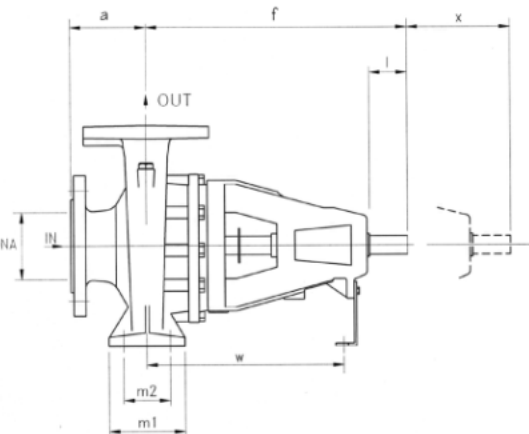
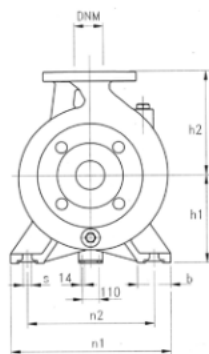
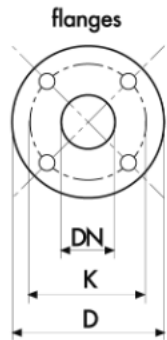

DIMENSIONS (mm)				
DN	D	K	holes	
			n°	Ø
32	140	100	4	18
40	150	110	4	18
50	165	125	4	18
65	185	145	4	18
80	200	160	8	18
100	220	180	8	18
125	250	210	8	18



DNA	DNM	DIMENSIONS (mm)																		Kg	
		a	f	h1	h2	m1	m2	n1	n2	s	b	i	d	t	u	x	w	l	L		M
50	32	80	360	132	160	100	70	240	190	14	50	50	24	27	8	100	260	535	320	445	38

### Notes

The information may be subject to change without notice. It is always advisable to contact our commercial department in order to get further information about the products, their technical specifications and warranty conditions. The Company is expressly relieved of any liability for the purchasing of a product not in line with the customer's needs, if not consulted beforehand for a specific consultancy.



### Working Curves

Pump type: CA32-160A

Curv n°:	CA32-160A
Date:	6/22/2022
Pump Speed	2900 rpm

Q (m3/h) 20 | H (m) 30 | Power [kW] 2.89 | Efficiency % 55.64 | NPSH (m) 3.46

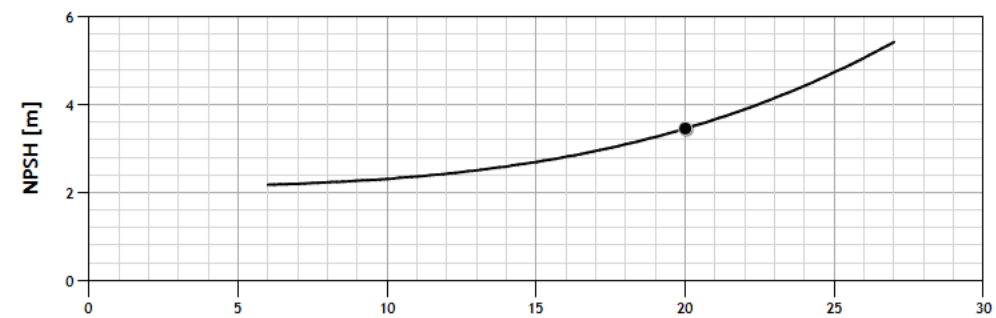
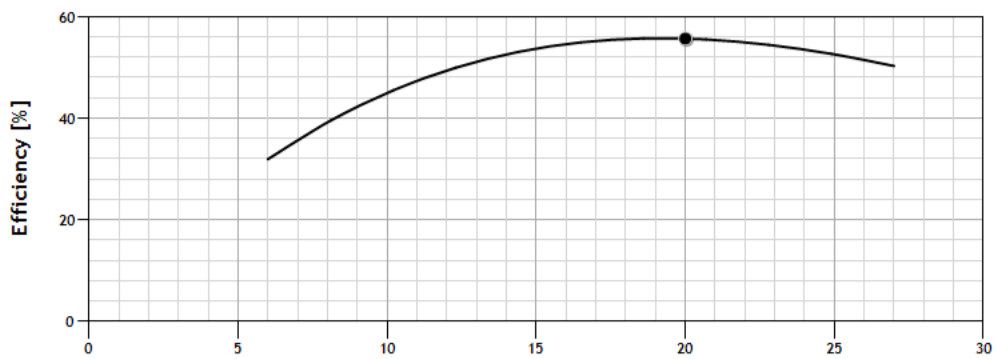
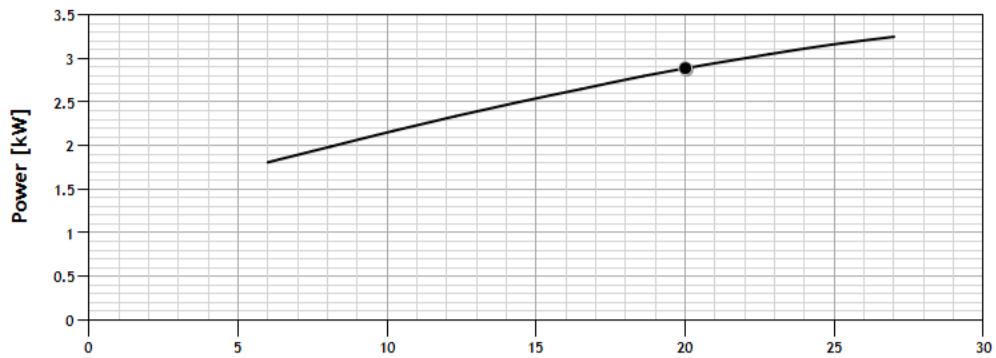
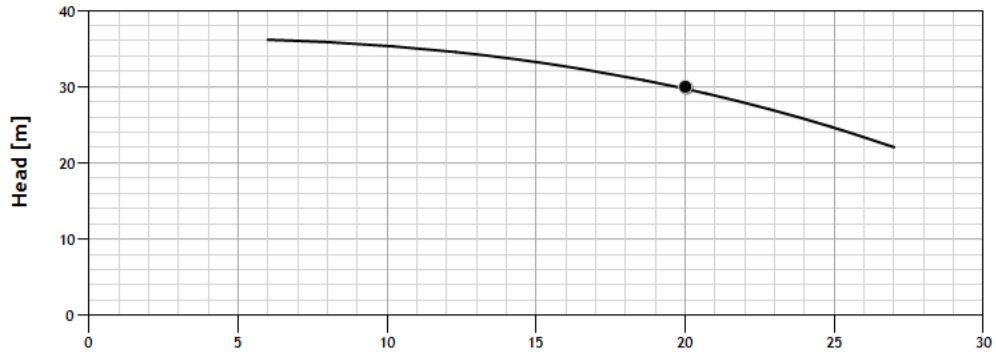

Flow Rate [m3/h]

MEI ≥ 0.4 (regulation EU N. 547/2012)  
Tolerances according to UNI ISO 9906 grade 3B